

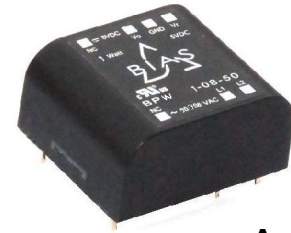

# BIAS 1/2 Watt Power Supply BPW 0.5 Series Data Sheet

Single (Vo) or Dual (Vo & Vr) output  
BPW 0.5-08-00, -08-33, -08-50  
BPW 0.5-14-00, -15-33, -14-50



Actual Size

The BPW Power Supply Module is an ideal solution for numerous control applications in lighting, sensing, smart building and power distribution where operation from 277VAC mains is required. This low-cost supply provides up to one half watt of output power at 8 or 14 VDC (Vo) and an optional 3.3 or 5 VDC (Vr) output for microprocessors, logic, timing circuits, transceivers, sensors or other control functions. A patented design incorporating a custom integrated circuit into a small package (0.55 in<sup>3</sup> [9.0 cm<sup>3</sup>]) the BIAS Module provides an immediate “drop-in” solution, requiring no additional external components.

## Operating Specifications

(@120VAC / 60 Hz / 25°C unless otherwise specified)

Electrical	
Input Voltage Range	90 - 308 VAC (50/60Hz)
Input Surge Withstand	345V, < 30 sec
Output Power (Pmax)	0.5 W min. (60Hz) 0.43 W min. (50Hz)
Efficiency	70% nom.
Output Vo (Peak)	8 or 14 VDC nom. +/- 5%
Line / Load Regulation Vo (Peak)	+/- 1% Po < Pmax
Temperature Regulation Vo (Peak)	+/- 2% Po < Pmax
Ripple Vo (@120 Hz) (@ 100 kHz)	1.00 V p:p 0.25 V p:p
Output Vr, 3.3 volt (+/- 5%)	For Vo = 8V, Ir out 53mA max, Io+Ir ≤ 63mA* For Vo = 14V, Ir out 23mA max, Io+Ir ≤ 36mA*
Output Vr, 5.0 volt (+/- 5%)	For Vo = 8V, Ir out 63mA max, Io+Ir ≤ 63mA* For Vo = 14V, Ir out 28mA max, Io+Ir ≤ 36mA*
No-load Consumption	30 mW typical @ Vin=120 VAC
Isolation	3000 VAC (meets UL / CSA & EN Product Safety)
Earth Leakage @ 120 VAC	< 10 uA
Short Circuit Protection	Continuous, Pin ≤ 0.6 w @ Vin = 120 VAC
Reliability @ 25° C, MIL HDBK-217F	> 500 Khr MTBF
Thermal	
Operating Temperature	-30 to +70° C
Operating Relative Humidity	0 – 95%, non-condensing
Storage Temperature	-40 to +105° C
Mechanical	
Package Size (L x W x H)	1.10 x 0.92 x 0.55 inches [27.94 x 23.24 x 13.97 mm]
Safety	
Safety Compliance	UL / EN 60950-1 2 <sup>nd</sup> Ed. (CB Report Available)
EMI Emissions	EN 55022, Class B, FCC Part 15, Class B

## Features

- **Universal Input (90-308 VAC, 50/60Hz)**
- **Small Size—0.55in<sup>3</sup> [9.0cm<sup>3</sup>]**
- **Low no-load input power <30mW**
- **Constant power mode, not current limit**
- **3000 VAC Isolation**
- **Up to 75% efficiency**
- **EN 55022, Class B; FCC Part 15, Class B**
- **Meets UL/CSA and EN Product Safety (ITE)**

**Bias Power AC/DC power supplies are designed to be applied in two major categories of applications...**

*Auxiliary*, where the Bias supply is one of two or more supplies and provides power for standby, housekeeping, biasing or other requirements. Generally, these supply 3.3V or 5.0V requirements from the Vr output. In some cases a small amount of Vo power is used.

*Second* is as a main or utility supply where Bias is the only supply and provides all power necessary for the product or system. Both Vr and Vo supplies are often utilized for optimum system performance.

The characteristics of the Vo and Vr outputs are different and each has application-specific benefits which can provide high value to the system designer.

Vo is a voltage-regulated output which has a constant power mode instead of a conventional current limit. This output is best suited to drive mechanical relays, solenoids, SSRs, capacitive loads, indicating lights, LEDs and as a source for isolated DC utility power which may be used directly or post-regulated with either a linear regulator or a DC/DC converter. Vo is self protecting, cannot be overloaded and can be shorted indefinitely. The graceful transition from voltage regulation to constant power along with the wide range of product ratings, allows the designer to select a supply tightly matched to the design load. There is no need to oversize a Bias Power supply. Unlike design-your-own, or partially complete modules where significant design margin is required, to stay far away from current limit, Bias's constant power alternative requires no such over-spec'ing.

Vr is also a voltage-regulated output and is thermally protected from overload. It has very low output ripple capable of driving microprocessors, logic, transceivers, sensors and other elements which require a low-noise, tightly-regulated supply. In addition, Vr is supplied internally by Vo. This means that any capacitance added to Vo can increase the hold-up time of Vr as well.

\*Note: maximum currents specified for constant voltage range only. See V-I curve on page 2 for Vo in constant power range.



# BIAS 1/2 Watt Power Supply

## BPW 0.5 Series Data Sheet

Single (Vo) or Dual (Vo & Vr) output

BPW 0.5-08-00, -08-33, -08-50

BPW 0.5-14-00, -15-33, -14-50

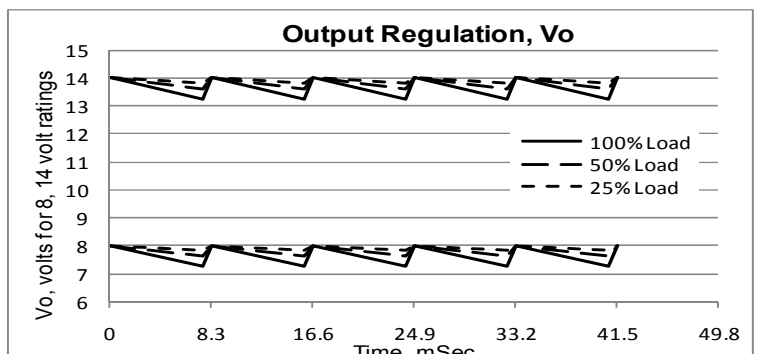
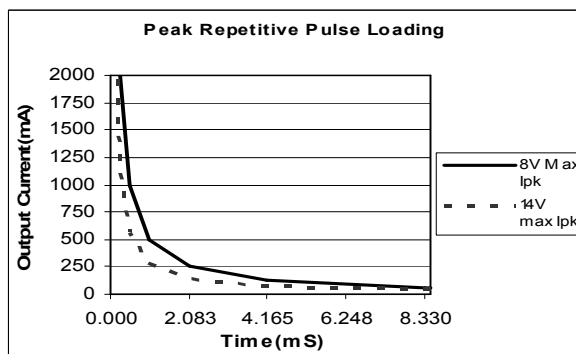
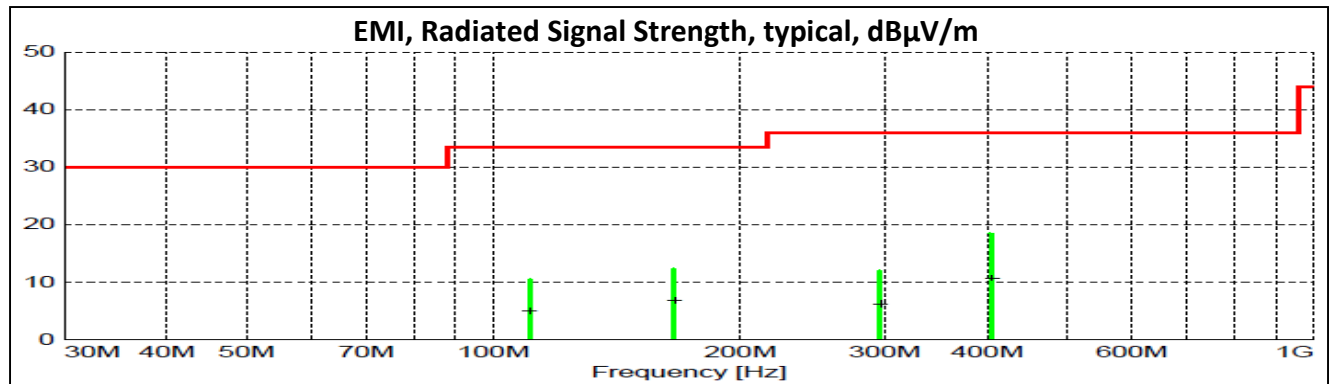
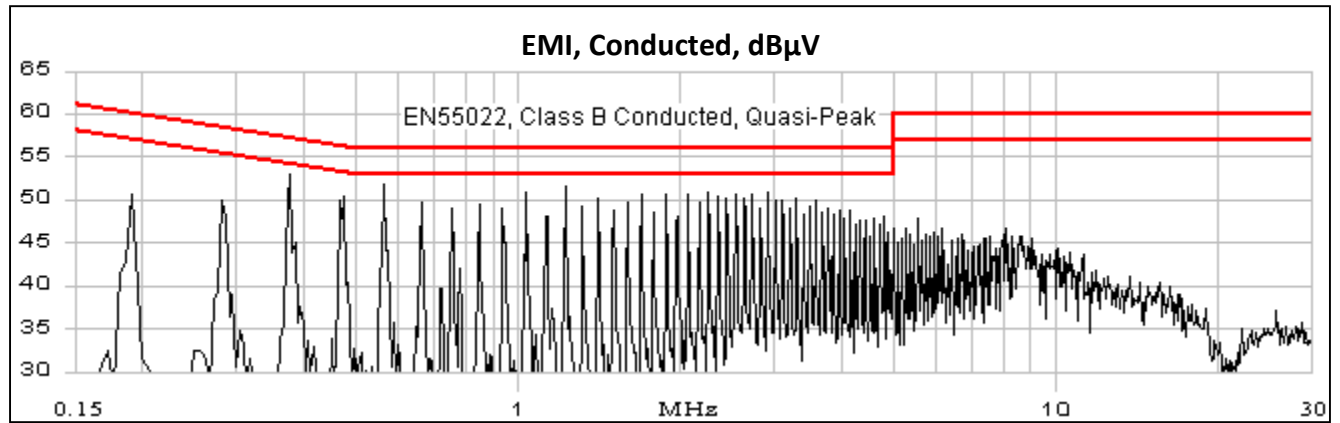
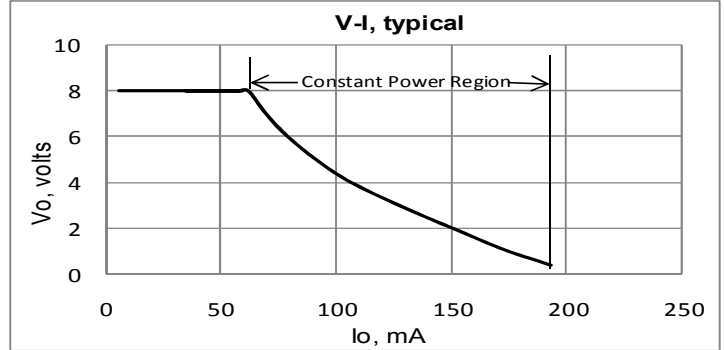
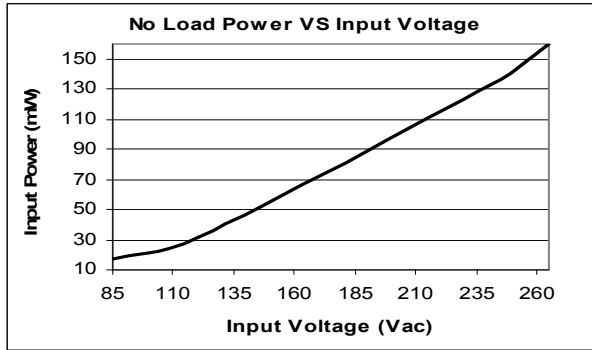



# BIAS 1/2 Watt Power Supply

## BPW 0.5 Series Data Sheet

Single (Vo) or Dual (Vo & Vr) output

BPW 0.5-08-00, -08-33, -08-50

BPW 0.5-14-00, -15-33, -14-50

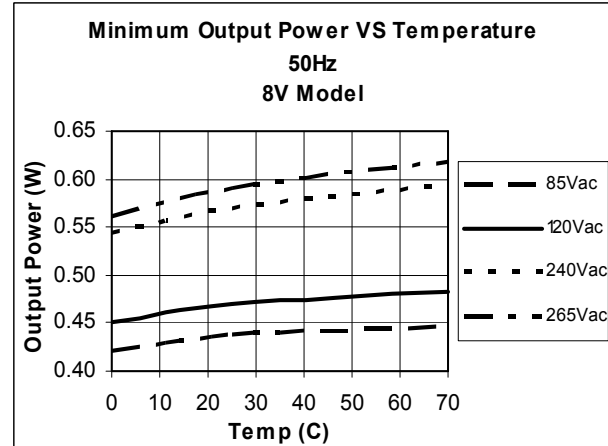
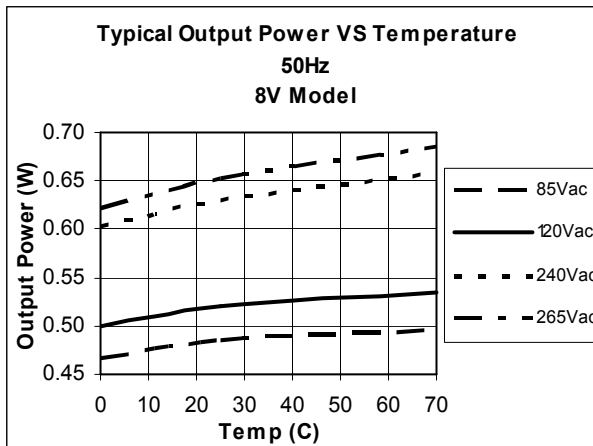
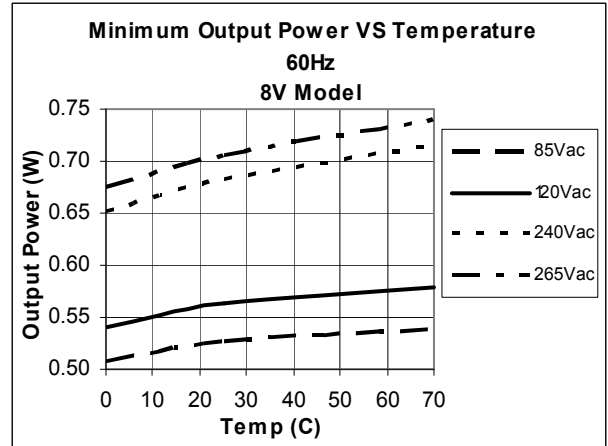
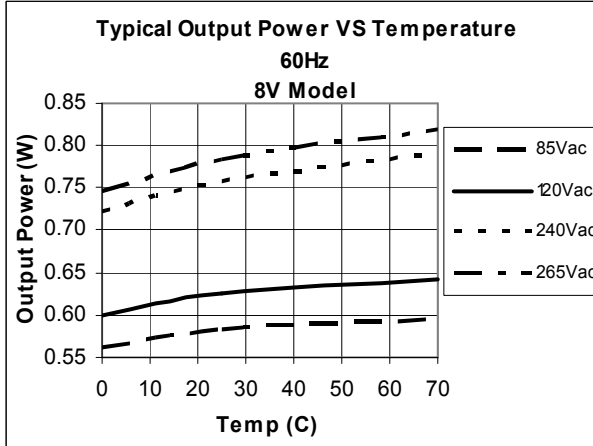



# BIAS 1/2 Watt Power Supply

## BPW 0.5 Series Data Sheet

Single (Vo) or Dual (Vo & Vr) output

BPW 0.5-08-00, -08-33, -08-50

BPW 0.5-14-00, -15-33, -14-50

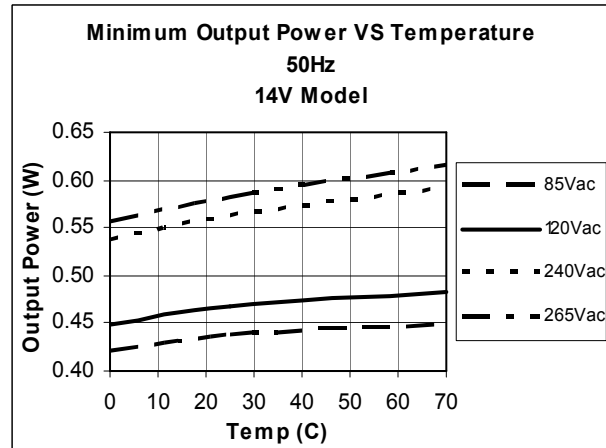
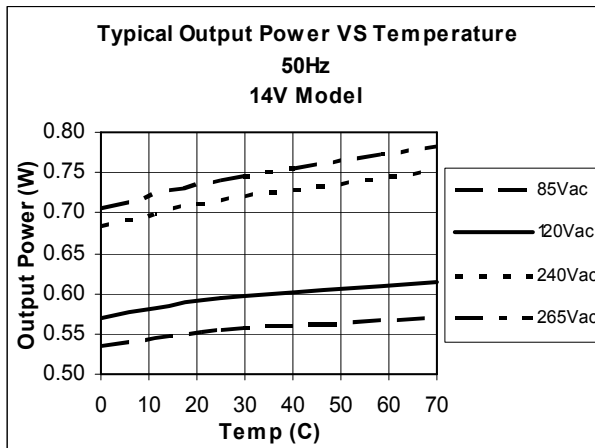
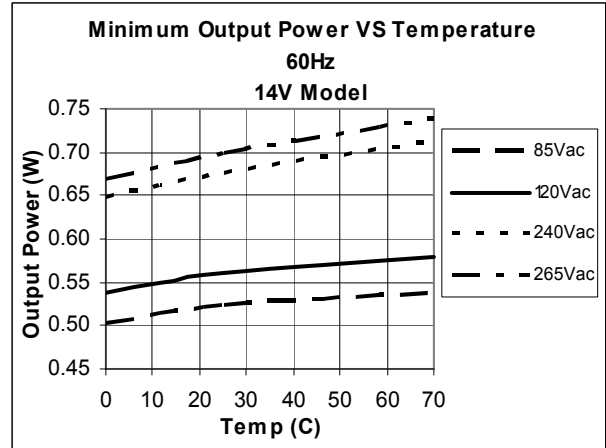
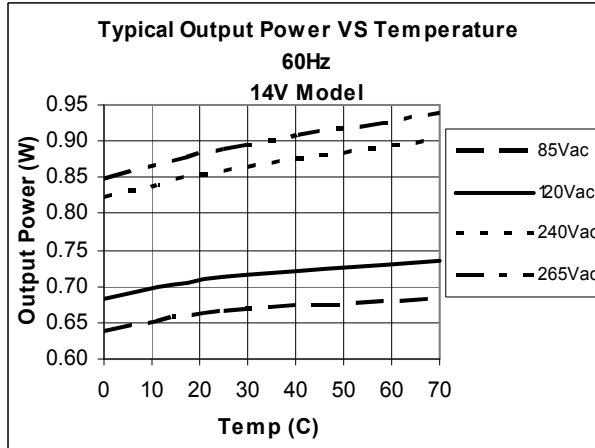



# BIAS 1/2 Watt Power Supply

## BPW 0.5 Series Data Sheet

Single (Vo) or Dual (Vo & Vr) output

BPW 0.5-08-00, -08-33, -08-50

BPW 0.5-14-00, -15-33, -14-50

### Part Number Designation

Part Number	Output Configuration	Vo	Vr
BPW 0.5-08-00	Single output	8 VDC	N/A
BPW 0.5-14-00	Single output	14 VDC	N/A
BPW 0.5-08-33	Dual Output	8 VDC	3.3 VDC
BPW 0.5-08-50	Dual Output	8 VDC	5 VDC
BPW 0.5-14-33	Dual Output	14 VDC	3.3 VDC
BPW 0.5-14-50	Dual Output	14 VDC	5 VDC

For custom configurations, contact BIAS Power.

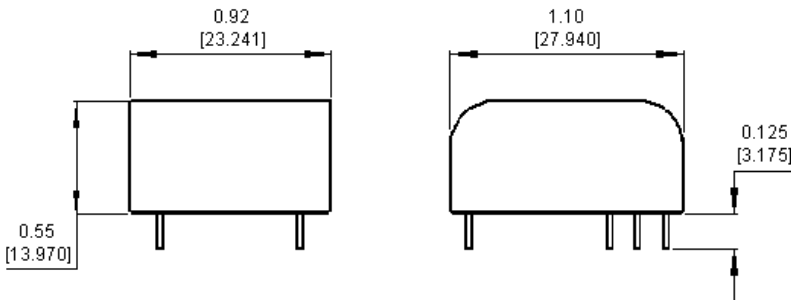

PIN DESIGNATOR	DESCRIPTION
L1	Input High
L2	Input Low
N/C	No Connection
Vo	Output
GND	Ground
Vr	Vr Output
N/C	No Connection

### Recommended Land Pattern, top view

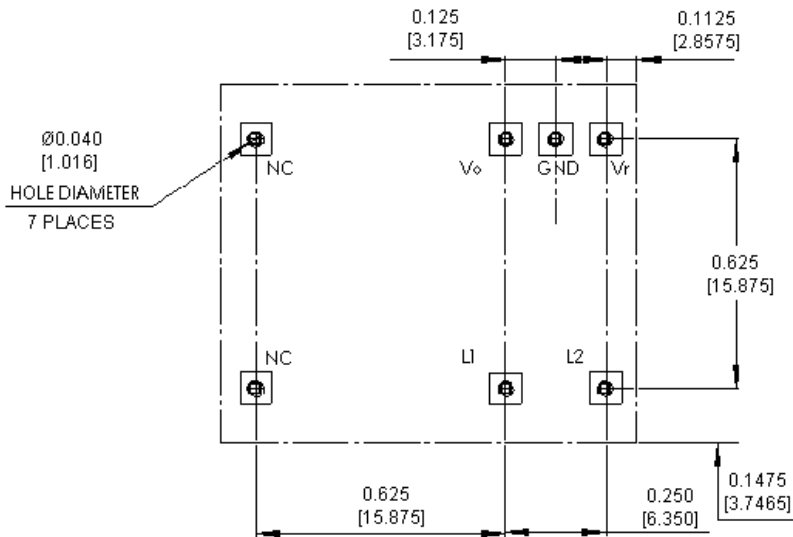

### Isolation, Bottom View

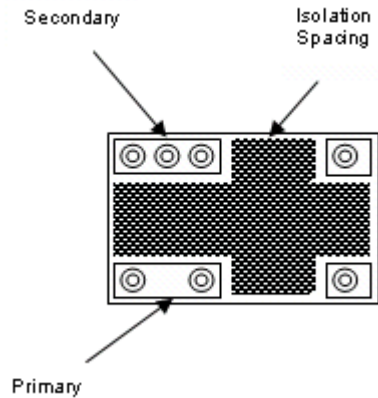

- NOTES**
1. Pins 0.031" [0.787 mm] round
  2. Pins extend 0.125" [3.175 mm] below stand-offs